

# Consumer Unit

## Design 10 High Integrity 63A ( $I_{nA}$ ) with SPD

For the distribution of power in a residential application, conforming to BS EN 61439-3 including Annex ZB (16kA rating).

The range of consumer units with a 63A rated current ( $I_{nA}$ ) have been designed for installations where the upstream overcurrent protection device (OCPD) is rated at 63 A or below.

Design 10 consumer unit is an entry level board designed for all applications and allows compliance with BS 7671:2018;

Regulation 421.1.201 within domestics (household) applications consumer units and similar assemblies shall comply with BS EN 61439-3 and shall have their enclosure manufactured from a non-combustible material.

Regulation 411.3.3 additional protection by means of a 30mA RCD.  
Regulation 314.1&2 segregation of circuits to avoid danger and minimise inconvenience in the event of a fault.

Regulation 522.6.202 protection of wiring concealed in walls or partitions with RCD 30mA. Regulation 531.3.3 Selection of appropriate RCD. Type A RCCBs can detect and respond to both AC and pulsating DC components.

Regulation 536.4.3.2 & 536.4.202 overload protection of switches and RCCBs. For installations where the upstream overcurrent protection is less than or equal to 63 A

Regulation 443.4 Protection against transient over voltages, provided by factory fitted type 2 SPD.

High integrity boards are designed to allow dedicated circuits to have individual 30mA protection to reduce any risk of nuisance tripping, whilst the rest of the installation is separated across two RCCBs.

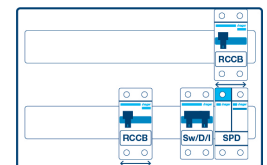
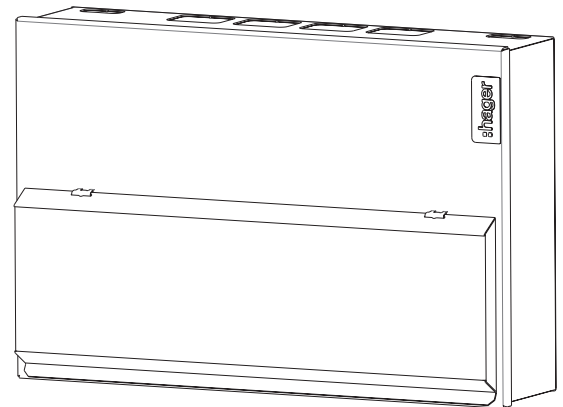

VML61014CUSPD

Description	Size	Cat ref.
8 Way High Integrity 63A Main Switch 2*63A 30mA Type A RCCB with Factory Fitted SPD	5	VML608CUSPD
10 Way High Integrity 63A Main Switch 2*63A 30mA Type A RCCB with Factory Fitted SPD	6	VML610CUSPD
14 Way High Integrity 63A Main Switch 2*63A 30mA Type A RCCB with Factory Fitted SPD	7	VML614CUSPD
6+10 Way High Integrity 63A Main Switch 2*63A 30mA Type A RCCB with Factory Fitted SPD	4(2)	VML60610CUSPD
6+10 Way High Integrity 63A Main Switch 2*63A 30mA Type A RCCB with Factory Fitted SPD	5(2)	VML61014CUSPD
6+10 Way High Integrity 63A Main Switch 2*63A 30mA Type A RCCB with Factory Fitted SPD	7(2)	VML61620CUSPD

## Features & Benefits

- Type A RCCBs for general purpose circuits and circuits containing equipment incorporating electronic components.
- High integrity layout allows RCBOs to be fitted separate to the RCCBs for reduction of nuisance tripping on essential circuits and splitting earth leakage across multiple RCDs
- -- Rear Knockouts for ease of cable entry – Cable protector plate (VM02CE) available as accessory
- Front cover retained screws – Prevents loss during installation
- Full metal DIN rail – Secure and stable attachment of devices
- Quick release clip on MCB/RCBO – Allows removal of MCB/RCBO with busbar still in place
- Optimised cabling space – DIN rail position allows maximum cabling space.
- Top mounted terminal rail for each row makes the wiring of the neutral and earth connections neat and simple.
- Torque settings displayed inside front cover – easily accessible to electrician during installation and maintenance.
- Factory Fitted Type 2 Surge Protection

### Technical Characteristics

Standards	BS EN 61439-3
Classification	Consumer Unit
Rated & Operational Voltage ( $U_n/U_e$ )	230V a.c 50 Hz
Rated Insulation Voltage ( $U_i$ )	320V a.c. 50Hz
Rated Frequency (fn)	50 Hz
Rated impulse withstand voltage ( $U_{imp}$ )	4kV
Rated Current of the Assembly ( $I_{nA}$ )	63A
Rated Current of an Outgoing Circuit $I_{nC}$	MCB 6A-63A (Marked Rated Current on Device) RCBO <b>ADA 1**G</b> - 40A - 45A (Marked Rated Current on Device) RCBO <b>ADA3**G</b> - 6A - 32A (Marked Rated Current on Device)
Rated Conditional Short Circuit of the Assembly ( $I_{cC}$ )	Annex ZB: 16kA rms at 250V, power factor 0.6 with equipment and arrangements specified in Hager's technical documentation/catalogue
Rated Current of the Assembly Circuit ( $I_{nC}$ )	RCCB 63A (Marked Rated Current on Device)
Protection against electric shock	Consumer Unit shall be installed in an electrical system conforming to IEC 60364 / BS 7671
Rated Diversity Factor (RDF) / Values of assumed loading	10 Way and above - 0.5

Note: RDF only applies to continuously and simultaneously loaded circuits. In principle, this means adjacent circuit breakers having a load on time exceeding 30 minutes or where a load not exceeding 30 minutes has an 'off' time less than the 'on' time will need to have the rated diversity factor applied as indicated.

Pollution Degree	2
Types of System Earthing for which the assembly is designed	TNC-S and TN-S when installed in an electrical system conforming to BS 7671
Intended locations	Indoor use only
Stationary assembly	
Degree of protection	IP2XC with door open / closed and full compliment of devices / blanks fitted. Note: Where cables are installed through the top wall of the enclosure, gaps of IP4X to be maintained.
Intended use	Intended for use in domestic (residential) or similar premises
Electromagnetic compatibility (EMC) classification	EMC environment B
External design	Wall mounted, surface type, enclosed assembly.
Mechanical impact protection	IK05
Type of construction	Fixed parts
Incoming Line/Neutral terminal	50mm <sup>2</sup>

### Accessories

Cable clamp	Secures supply cables on entry to main incoming device	<b>VA10MT</b>
Grommet strip	For protecting cables against damage when entering board	<b>VM05GS</b>
Rear stand off plates	To stand consumer unit off wall allowing surface mounted cables to enter through rear of unit	<b>VM01SP</b>

### Devices

MCB 6kA 6A to 63A B Curve	<b>MTN***</b>
Single Pole, Single Mod Reduced Height RCBO 6kA, 6A - 32A Type A	<b>ADA3**G</b>
Single Pole, Single MOD Standard Height RCBO 40A, 45A Type A	<b>ADA1**G</b>

### Design 10 Dimensions (mm)

		Enclosure Size					
		5	6	7	4(2)	5(2)	7(2)
	Height	246	246	246	486	486	486
	Width	370	406	478	299	370	478
	Depth 1	83	83	83	83	83	83
	Depth 2	100	100	100	100	100	100
		Number of Knockouts					
<input type="checkbox"/>	Top Face 30 x 25 (mm)	2	2	2	2	2	2
<input type="checkbox"/>	Top Face 40 x 30 (mm)	4	6	6	4	4	6
<input type="checkbox"/>	Back 100 x 50 (mm)	3	3	3	2	6	6
<input type="checkbox"/>	Bottom Face 30 x 25 (mm)	4	5	5	4	4	5

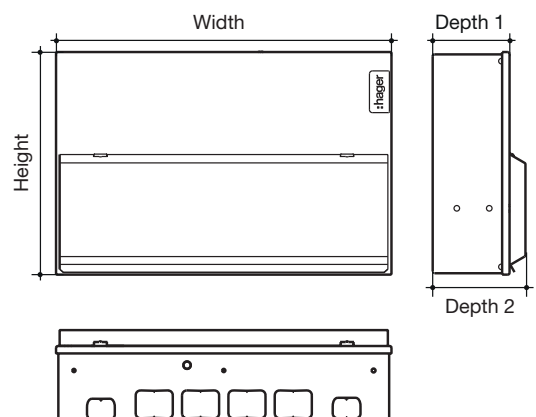

**Surge protection devices**

Consumer units with SPD in the part reference come with a Type 2 (T2) surge protection device. All connections to and from the surge protection device are made at the factory. The phase is protected by a Metal Oxide Varistor (MOV) and the neutral by a spark gap device. The Metal Oxide Varistor will degrade each time it deals with high voltage or electromagnetic disturbances, when it is end of life the flag will turn red and the cartridge will require to be changed. At this point the cartridge will fail open circuit and the device will no longer provide surge protection. Simply remove the cartridge and replace with a new cartridge (SPD015D). The rest of the installation will remain unaffected.

**To remove a cartridge when the flag is red**

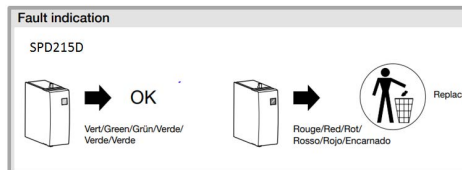
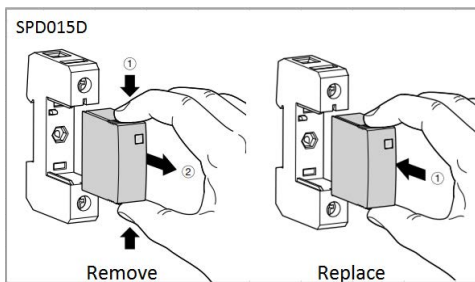

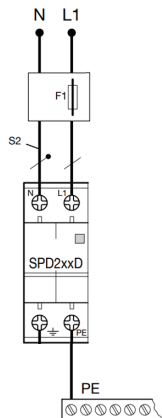

**Position of SPD in installation**

TT/ TN-S/ TNC-S



Overcurrent protection (F1) is provided by the upstream over current protection device (OCPD) which for a consumer unit is generally the service cut-out fuse.

**SPD Characteristics**

	$I_n$ (8/20 $\mu$ s)	$I_{max}$ (8/20 $\mu$ s)	$U_p$	$U_c$	F1 max $\ominus$	$I_{pe}$	$I_{scrr}$	 
SPD215D	5 kA	15 kA	$\leq 1$ kV	275 V (50/60 Hz)	125 A gG	$< 5 \mu$ A	10 kA <sub>rms</sub>	SPD015D