

Tebis application software

TL204B V 3.x Lighting and heating
 TL206C V 3.x Lighting and heating
 TL207A V 3.x Lighting and Shutters
 TL208A V 3.x Lighting and Shutters
 TL202A V 3.x Lighting, Shutters and Ventilation
 Lighting functions

	Product reference	Product designation
	TXA204A/B/C/D TXA206A/B/C/D TXA207A/B/C/D TXA208A/B/C/D TXB202A	Output module 4-fold 4/10/16A 230V~/ 16 A capacitive loads Output module 6-fold 4/10/16A 230V~/ 16 A capacitive loads Output module 10-fold 4/10/16A 230V~/ 16 A capacitive loads Output module 8-fold 4/10/16A 230V~/ 16 A capacitive loads with local command separated from bus Output module 2-fold 4A 230V~, flush mounted

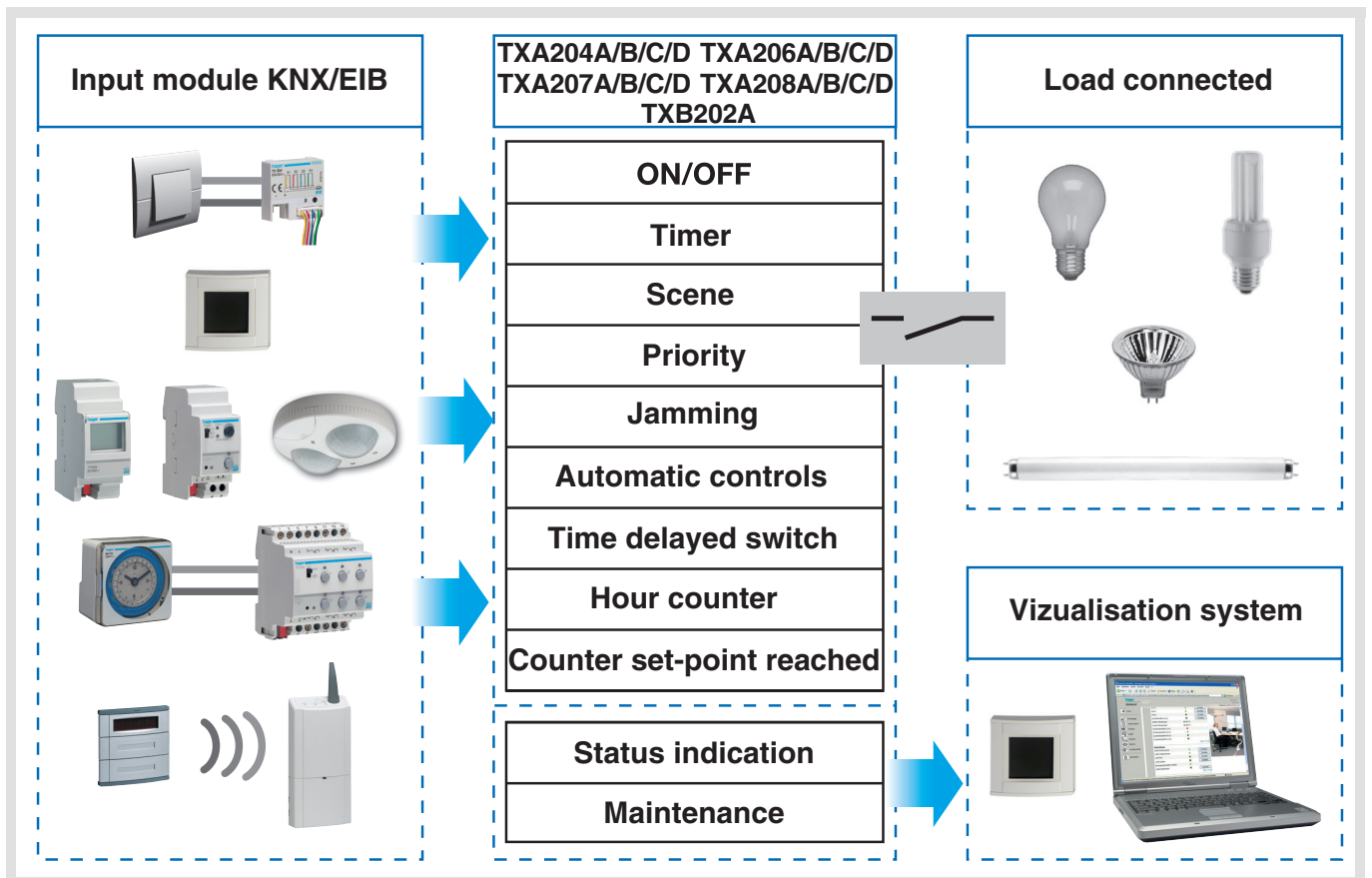

Summary

1. Presentation of the Lighting functions of the TL204B-TL206C-TL207A-TL208A-TL202A applications.....	3
2. Configuration and parameters of the Lighting functions	4
2.1 General parameters.....	4
2.2 Objects List.....	5
2.3 Function descriptions.....	5
3. Main characteristics	17
4. Physical addressing	18

1. Presentation of the Lighting functions of the TL204B-TL206C-TL207A-TL208A-TL202A applications

The TL204B-TL206C-TL207A-TL208A-TL202A application softwares allow each output to be individually configured for Lighting applications

The main functions are the following:

■ ON/OFF

The ON/OFF function is used to switch a lighting circuit ON or OFF.

The command may come from switches, pushbuttons or automatic controls.

■ Status indication

The Status indication function displays the status of the output contact.

It allows a toggle function to be created by sending the status indication to each pushbutton of the group.

■ Timer

The Timer function is used to switch a lighting circuit ON or OFF for an adjustable time.

Depending on the operation mode selected, the output may be delayed for ON or OFF switching. The timer can be interrupted before the end of the delay time. An adjustable cut-OFF pre-warning indicates the end of the delay time by inverting the status of the output for 1 sec.

■ Time limited toggle switch

The Time delayed switch function combines a toggle function and a cut-off delay.

Pressing briefly a pushbutton inverts the output. If the output is ON, it switches automatically to OFF after a programmable delay time (energy savings).

Application: lighting of attics, cellars, sheds, etc.

■ Priority

The Priority function allows overriding an output to a definite status, ON or OFF.

This command has the highest priority. No other command is taken into account if a priority is active. Only a priority end command re-enables the other commands.

Application: Maintaining lighting ON for safety reasons.

■ Jamming

The Jamming function allows locking an output in its current status.

This command has priority, but at a lower level than the Priority function. Jamming forbids any action until a jamming end command is sent.

The jamming duration can be delayed.

■ Scene

The Scene function groups a set of outputs. These outputs can be set to an adjustable predefined status.

Pressing a single pushbutton activates a scene.

Each output may be integrated into 32 different scenes.

■ Timer Automatic controls

The Timer and Automatic controls function allow the outputs to be controlled by:

- Timer functions: Timer/toggle change over, Switching delay, Tripping delay, Switching and tripping delay, Timer.
- Automatic control functions: Authorization, Logical AND or Logical OR.

■ Hours counter

The Hours counter function allows counting the ON or OFF time of an output.

A set-point triggering an alarm may be programmed.

■ Manual mode *

The Manual mode is used to isolate the product from the bus.

In this mode, it is possible to override manually each output.

*Except reference TXB202A

2. Configuration and parameters of the Lighting functions

2.1 General parameters

■ ETS version selection

This parameter allows the presentation of the parameters to be optimised according to the ETS version used. Go to the ETS Version screen and select the required version: ETS2 or ETS3.

Default value: ETS3.

■ Function selection

Go to the General screen and select Lighting for all outputs concerned.

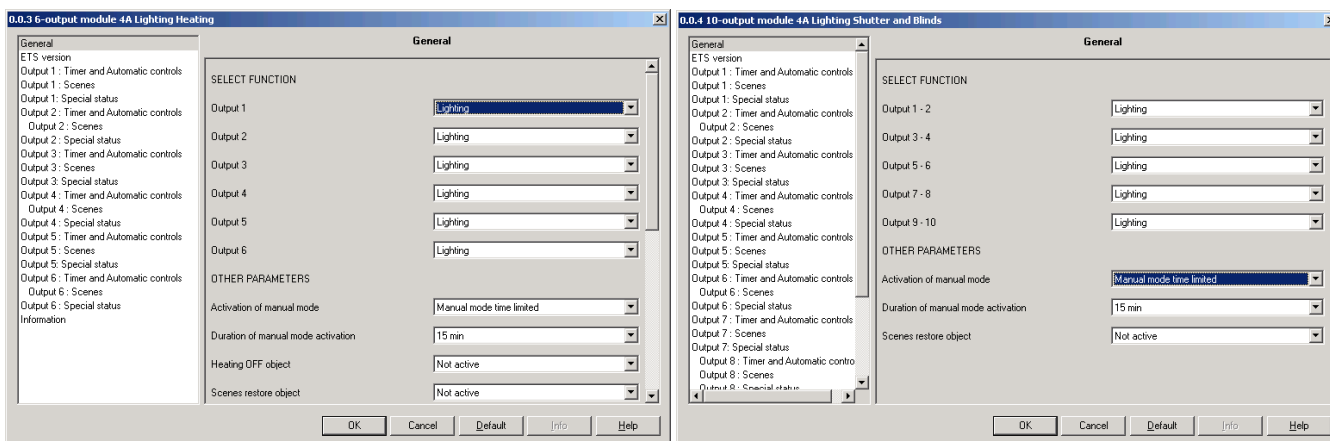

ref. TXA204-206

Screen 1

ref. TXA207-208

■ Other parameters

Designation	Description	Values
Activation of Manual mode*	This parameter enables or disables the 2 position switch located on the front side of the product. This switch allows selecting the Manual mode or the Auto mode. In Manual mode, the outputs may be controlled using the pushbuttons on the front side of the product. In Auto mode, the outputs are controlled by the instructions coming from the bus.	Manual mode authorized, Manual mode inhibited, Manual mode time limited. - Manual mode authorized: the manual mode can be activated at any time. - Manual mode inhibited: the switch is permanently disabled. Switching to manual mode is impossible. - Manual mode time limited: the manual mode can be activated for a limited duration. Default value: Manual mode authorized.
Duration of manuel mode activation**	This parameters defines the duration of activation of the manual mode.	15, 30, 60 min. Default value: 15 min.
Scene restore object*** (see also Scene function)	If the value is Authorized, the values associated to the scenes at the last download are restored upon reception of this object.	Not active, Active. Default value: Not active.

* When the position of the switch is not in line with the status of the product, the indicators associated with the outputs light up sequentially.

** This parameter only is visible if the Manual mode activation parameter has the value: Manual mode time limited.

***Only the Scenes restoration object is available for the reference TXB202A.

2.2 Objects List

Number	Name	Object Function	Length	C	R	W	T	U	Priority	Number	Name	Object Function	Length	C	R	W	T	U	Priority
0	Output 1	ON/OFF	1 bit	C	R	W	-	U	Low	36	Output 8	Timer	1 bit	C	R	W	-	U	Low
1	Output 1	Timer	1 bit	C	R	W	-	U	Low	37	Output 8	Priority	2 bit	C	R	W	-	U	Low
2	Output 1	Priority	2 bit	C	R	W	-	U	Low	38	Output 8	Scene	1 Byte	C	R	W	-	U	Low
3	Output 1	Scene	1 Byte	C	R	W	-	U	Low	39	Output 8	Status indication	1 bit	C	R	-	T	U	Low
4	Output 1	Status indication	1 bit	C	R	-	T	U	Low	40	Output 9	ON/OFF	1 bit	C	R	W	-	U	Low
5	Output 2	ON/OFF	1 bit	C	R	W	-	U	Low	41	Output 9	Timer	1 bit	C	R	W	-	U	Low
6	Output 2	Timer	1 bit	C	R	W	-	U	Low	42	Output 9	Priority	2 bit	C	R	W	-	U	Low
7	Output 2	Priority	2 bit	C	R	W	-	U	Low	43	Output 9	Scene	1 Byte	C	R	W	-	U	Low
8	Output 2	Scene	1 Byte	C	R	W	-	U	Low	44	Output 9	Status indication	1 bit	C	R	-	T	U	Low
9	Output 2	Status indication	1 bit	C	R	-	T	U	Low	45	Output 10	ON/OFF	1 bit	C	R	W	-	U	Low
10	Output 3	ON/OFF	1 bit	C	R	W	-	U	Low	46	Output 10	Timer	1 bit	C	R	W	-	U	Low
11	Output 3	Timer	1 bit	C	R	W	-	U	Low	47	Output 10	Priority	2 bit	C	R	W	-	U	Low
12	Output 3	Priority	2 bit	C	R	W	-	U	Low	48	Output 10	Scene	1 Byte	C	R	W	-	U	Low
13	Output 3	Scene	1 Byte	C	R	W	-	U	Low	49	Output 10	Status indication	1 bit	C	R	-	T	U	Low
14	Output 3	Status indication	1 bit	C	R	-	T	U	Low	52	Output 1	Jamming	1 bit	C	R	W	-	U	Low
15	Output 4	ON/OFF	1 bit	C	R	W	-	U	Low	54	Output 1	Scene 1 bit	1 bit	C	R	W	-	U	Low
16	Output 4	Timer	1 bit	C	R	W	-	U	Low	57	Output 1	Time limited toggle s...	1 bit	C	R	W	-	U	Low
17	Output 4	Priority	2 bit	C	R	W	-	U	Low	59	Output 2	Jamming	1 bit	C	R	W	-	U	Low
18	Output 4	Scene	1 Byte	C	R	W	-	U	Low	64	Output 2	Time limited toggle s...	1 bit	C	R	W	-	U	Low
19	Output 4	Status indication	1 bit	C	R	-	T	U	Low	66	Output 3	Jamming	1 bit	C	R	W	-	U	Low
20	Output 5	ON/OFF	1 bit	C	R	W	-	U	Low	71	Output 3	Time limited toggle s...	1 bit	C	R	W	-	U	Low
21	Output 5	Timer	1 bit	C	R	W	-	U	Low	73	Output 4	Jamming	1 bit	C	R	W	-	U	Low
22	Output 5	Priority	2 bit	C	R	W	-	U	Low	78	Output 4	Time limited toggle s...	1 bit	C	R	W	-	U	Low
23	Output 5	Scene	1 Byte	C	R	W	-	U	Low	80	Output 5	Jamming	1 bit	C	R	W	-	U	Low
24	Output 5	Status indication	1 bit	C	R	-	T	U	Low	85	Output 5	Time limited toggle s...	1 bit	C	R	W	-	U	Low
25	Output 6	ON/OFF	1 bit	C	R	W	-	U	Low	87	Output 6	Jamming	1 bit	C	R	W	-	U	Low
26	Output 6	Timer	1 bit	C	R	W	-	U	Low	92	Output 6	Time limited toggle s...	1 bit	C	R	W	-	U	Low
27	Output 6	Priority	2 bit	C	R	W	-	U	Low	94	Output 7	Jamming	1 bit	C	R	W	-	U	Low
28	Output 6	Scene	1 Byte	C	R	W	-	U	Low	99	Output 7	Time limited toggle s...	1 bit	C	R	W	-	U	Low
29	Output 6	Status indication	1 bit	C	R	-	T	U	Low	101	Output 8	Jamming	1 bit	C	R	W	-	U	Low
30	Output 7	ON/OFF	1 bit	C	R	W	-	U	Low	106	Output 8	Time limited toggle s...	1 bit	C	R	W	-	U	Low
31	Output 7	Timer	1 bit	C	R	W	-	U	Low	108	Output 9	Jamming	1 bit	C	R	W	-	U	Low
32	Output 7	Priority	2 bit	C	R	W	-	U	Low	113	Output 9	Time limited toggle s...	1 bit	C	R	W	-	U	Low
33	Output 7	Scene	1 Byte	C	R	W	-	U	Low	115	Output 10	Jamming	1 bit	C	R	W	-	U	Low
34	Output 7	Status indication	1 bit	C	R	-	T	U	Low	120	Output 10	Time limited toggle s...	1 bit	C	R	W	-	U	Low
35	Output 8	ON/OFF	1 bit	C	R	W	-	U	Low	123	All outputs	Maintenance	2 Byte	C	R	-	T	U	Low

2.3 Function descriptions

■ ON/OFF functions and Status indication

The ON/OFF function is used to switch the output ON or OFF using the ON/OFF object. The status of the output depends on the activation of other functions and of the associated parameters: priority, output type, automatic control, scene, etc. The status of the output is indicated on the bus by the Status indication object. The physical status of the output is indicated on the bus by the Status indication object.

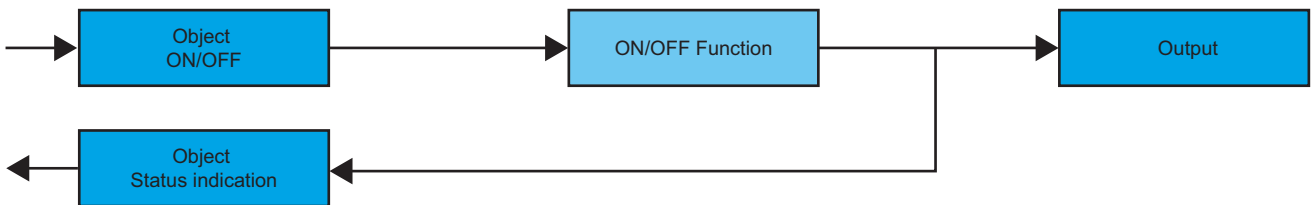

■ Timer function

The Timer function is used to switch a lighting circuit ON or OFF for an adjustable time. The function is started by the Timer object.

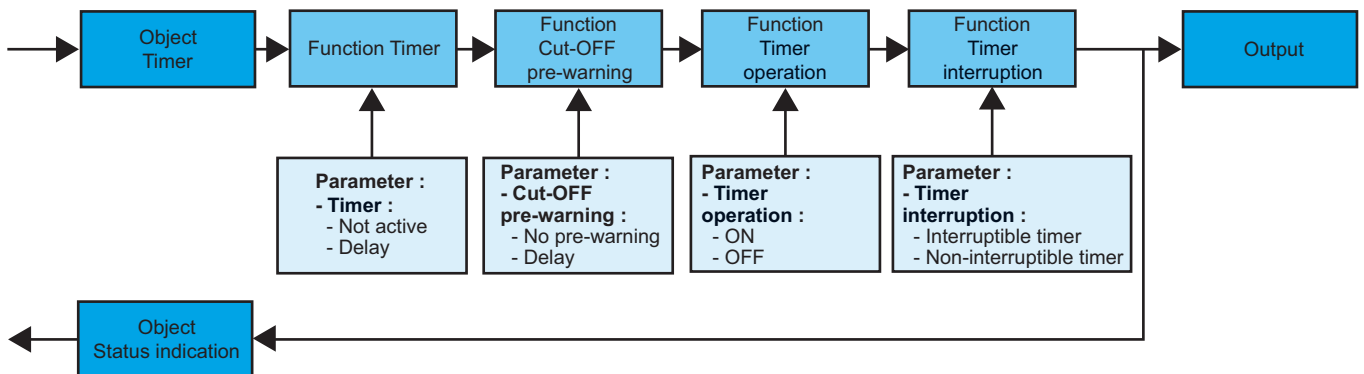

→ Parameters

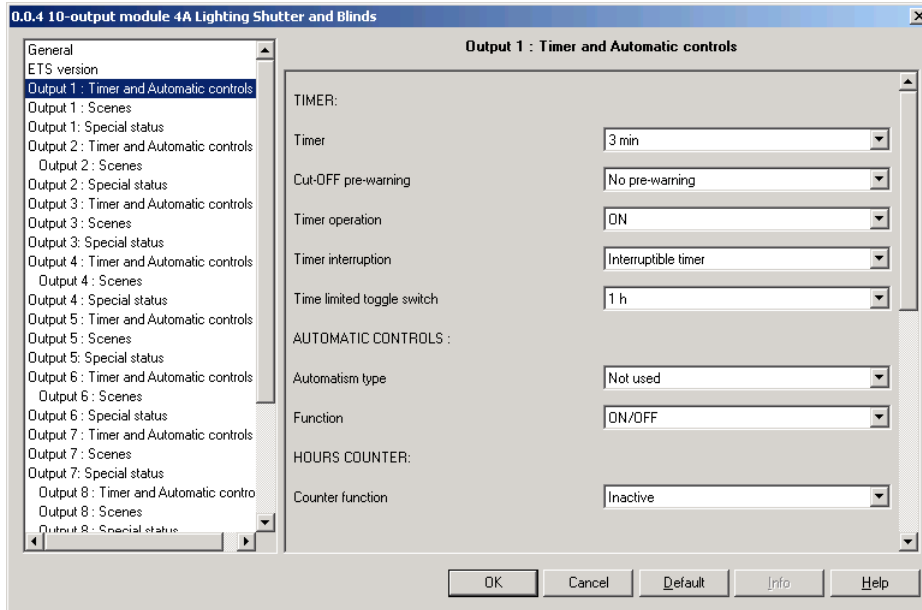

Screen 2

Designation	Description	Values
Timer	This parameter defines the length of the delay time.	Not active, Range [0.5 s 24 h]* Default value: 3 min.
Cut-OFF pre-warning (for ON operation)	When the pre-warning is active, the output switches to OFF for 1 sec. The parameter value defines the time before the end of the delay time, when the pre-warning will be applied.	No pre-warning, 15 s, 30 s, 1 min. Default value: No pre-warning.
Timer operation	This parameter defines whether the delay time triggers an ON or an OFF status.	ON, OFF Default value: ON.
Timer interruption	This parameter allows or not the interruption of the timer when the associated pushbutton is pressed for a long time.	Interruptible timer, Non-interruptible timer, Default value: Interruptible timer.

* Setting range [0.5 s 24 h]

0.5 s, 1 s, 2 s, 3 s, 5 s, 10 s, 15 s, 20 s, 30 s, 40 s, 45 s, 50 s, 1 min, 1 min 15 s, 1 min 30 s, 2 min, 2 min 30 s, 3 min, 4 min, 5 min, 6 min, 7 min, 8 min, 9 min, 10 min, 11 min, 12 min, 13 min, 14 min, 15 min, 20 min, 30 min, 40 min, 50 min, 1 h, 1 h 30 min, 2 h, 2 h 30 min, 3 h, 3 h 30 min, 4 h, 5 h, 6 h, 12 h, 24 h.

Note:

- Timer commands repeated n times during the first ten seconds after the beginning of the delay time multiply the duration of the delay time by n times the value of the Timer parameter
- Timer commands repeated n times within 10 seconds after the beginning of the delay time restart the timer only once.

■ Time limited toggle switch function

The Time limited toggle switch function allows a toggle with a settable switch-off delay time to be created (energy savings). This function is started by the Time limited toggle switch object.

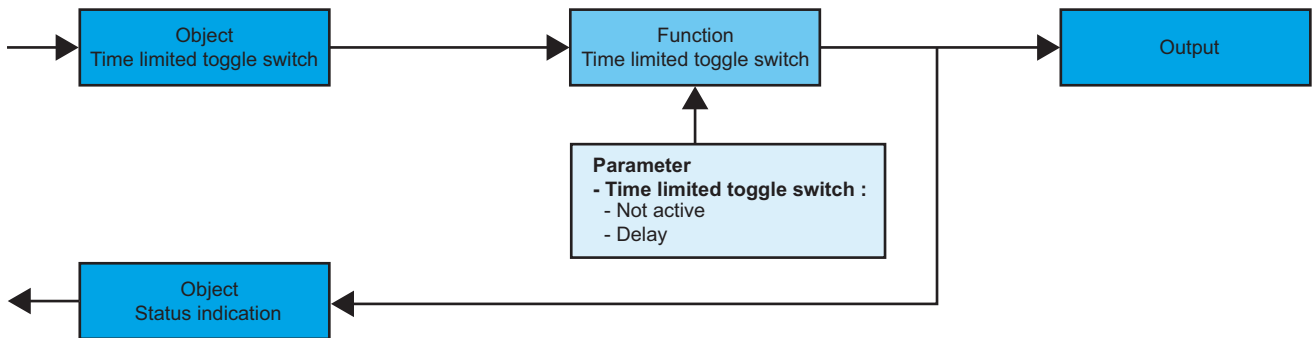

→ Parameter Setting screen: See "Screen 2".

→ Parameter

Designation	Description	Values
Time limited toggle switch	This parameter defines the duration of the switch-off delay time.	Not active, Range [0.5 s 24 h]* Default value: 1 h.

* Setting range [0.5 s 24 h]

0.5 s, 1 s, 2 s, 3 s, 5 s, 10 s, 15 s, 20 s, 30 s, 40 s, 45 s, 50 s, 1 min, 1 min 15 s, 1 min 30 s, 2 min, 2 min 30 s, 3 min, 4 min, 5 min, 6 min, 7 min, 8 min, 9 min, 10 min, 11 min, 12 min, 13 min, 14 min, 15 min, 20 min, 30 min, 40 min, 50 min, 1 h, 1 h 30 min, 2 h, 2 h 30 min, 3 h, 3 h 30 min, 4 h, 5 h, 6 h, 12 h, 24 h.

■ Priority function

The Priority function allows the outputs to be forced and maintained at a definite ON or OFF status imposed by the input. This function is started by the Priority object. Priority is the function with the highest priority. Only a priority-end command ends the Priority and re-authorizes the bus commands to be taken into consideration.

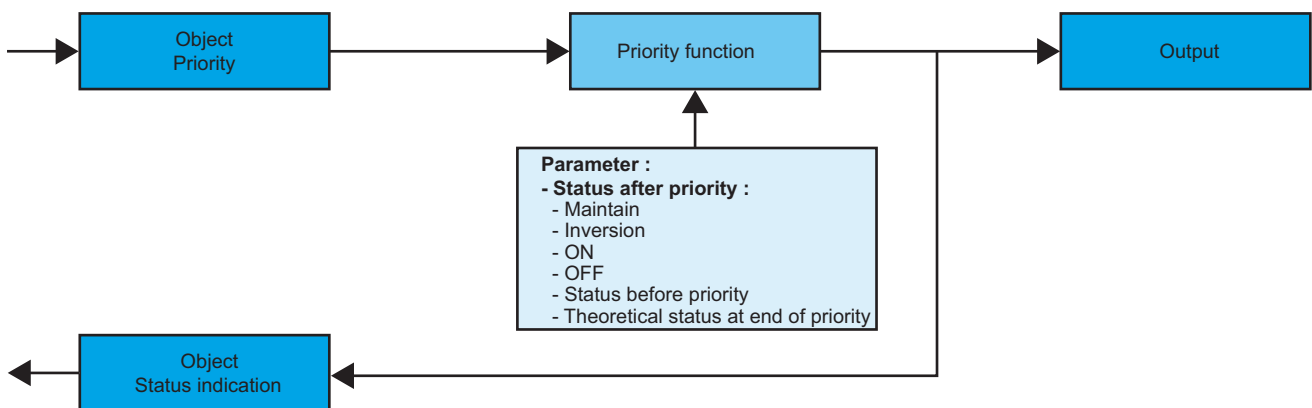

→ Description of the Priority object.

Bit 1	Bit 0
Output behaviour	

Output behaviour	00 = Priority-end 01 = Priority-end 10 = Priority OFF 11 = Priority ON
------------------	---

→ Parameter

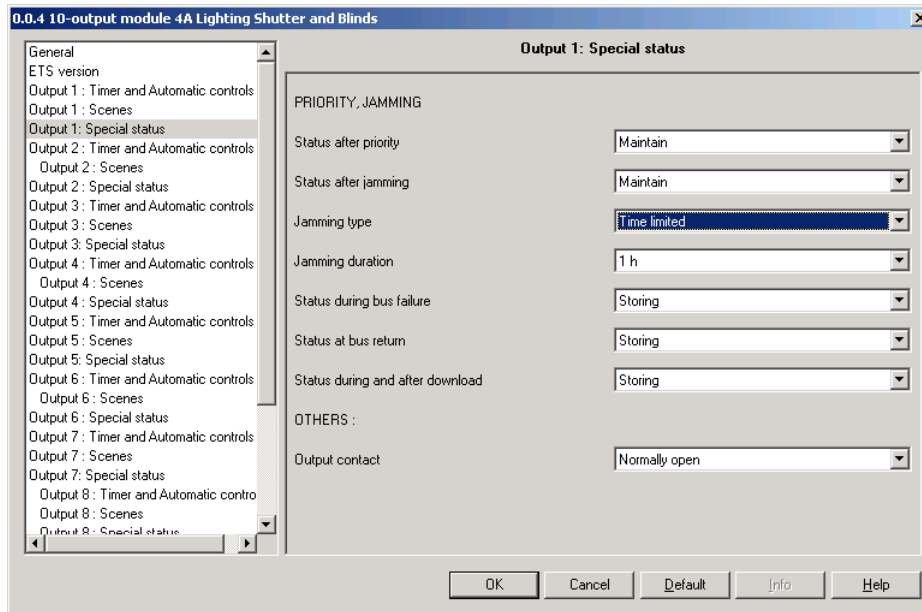

Screen 3

Designation	Description	Values
Status after priority	This parameter defines the output status to be applied at the end of the Priority.	<p>Maintain, Inversion, ON, OFF, Status before priority, Theoretical status at end of priority.</p> <ul style="list-style-type: none"> - Maintain: maintains the output at the status active during Priority. - Inversion: inversion of the output status with regards to the status active during Priority (ON to OFF and OFF to ON). - ON: switches the output to ON. - OFF: switches the output to OFF. - Status before priority: switches the output to the status active before the Priority command. - Theoretical status at end of priority: switches the output to the status that would be active if no Priority command had occurred. <p>Default value: Maintain.</p>

■ Jamming function

The Jamming function allows the outputs to be locked in their current status. This function is started by the Jamming object. The Jamming function is the function with the second highest priority after Priority. A Jamming end command ends the jamming and allows again taking the commands from the bus into consideration. A Priority command ends the Jamming.

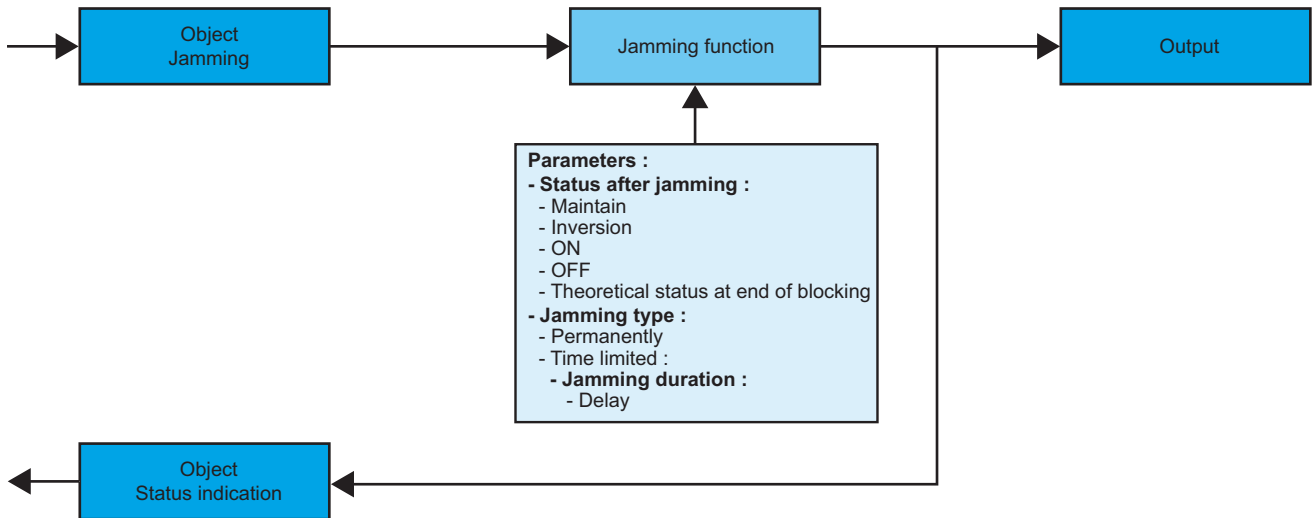

→ Parameter Setting screen: See "Screen 3".

→ Parameters

Designation	Description	Values
Status after jamming	This parameter defines the output status to be applied at the end of the Jamming.	Maintain, Inversion, ON, OFF, Theoretical status at end of blocking. - Maintain: maintains the output at the status active during Jamming. - Inversion: inversion of the output status with regards to the status active during Jamming (ON to OFF and OFF to ON). - ON: switches the output to ON. - OFF: switches the output to OFF. - Theoretical status at end of blocking: switches the output to the status that would be active if no Jamming command had occurred. - Default value: Maintain.
Jamming type	This parameter defines whether Jamming is permanent or time-limited.	Permanently, Time limited. Time limited: Jamming is active for a parameterisable limited duration. Default value: Permanently.
Jamming duration**	This parameter defines the Jamming duration.	Range [0 s 24 h]* Default value: 1 h.

* Setting range [0 s 24 h]

0 s, 0.5 s, 1 s, 2 s, 3 s, 5 s, 10 s, 15 s, 20 s, 30 s, 40 s, 45 s, 50 s, 1 min, 1 min 15 s, 1 min 30 s, 2 min, 2 min 30 s, 3 min, 4 min, 5 min, 6 min, 7 min, 8 min, 9 min, 10 min, 11 min, 12 min, 13 min, 14 min, 15 min, 20 min, 30 min, 40 min, 50 min, 1 h, 1 h 30 min, 2 h, 2 h 30 min, 3 h, 3 h 30 min, 4 h, 5 h, 6 h, 12 h, 24 h.

** This parameter is only visible when the Jamming type parameter has the value: Time limited.

■ Scene function

A scene is used to control a group of outputs. Each of the outputs in the group will be set to a status pre-defined for the scene. The group of outputs is created beforehand by establishing the link between the outputs that must belong to the scene and the pushbutton that will trigger the scene. Each output may be integrated into 32 different scenes. The status of each output may be defined by parameterising, by learning in the room using the pushbuttons of the installation or on the product.

A. Configuration and storing by parameterisation

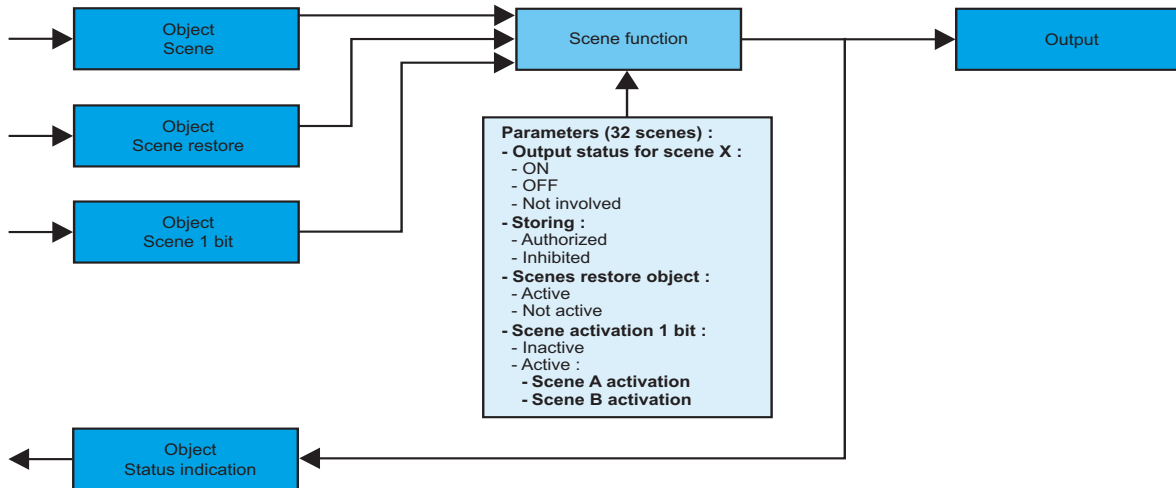

→ Description of the Scene object (1 byte)

7	6	5	4	3	2	1	0
Learn	X	Scene number					

→ Parameters

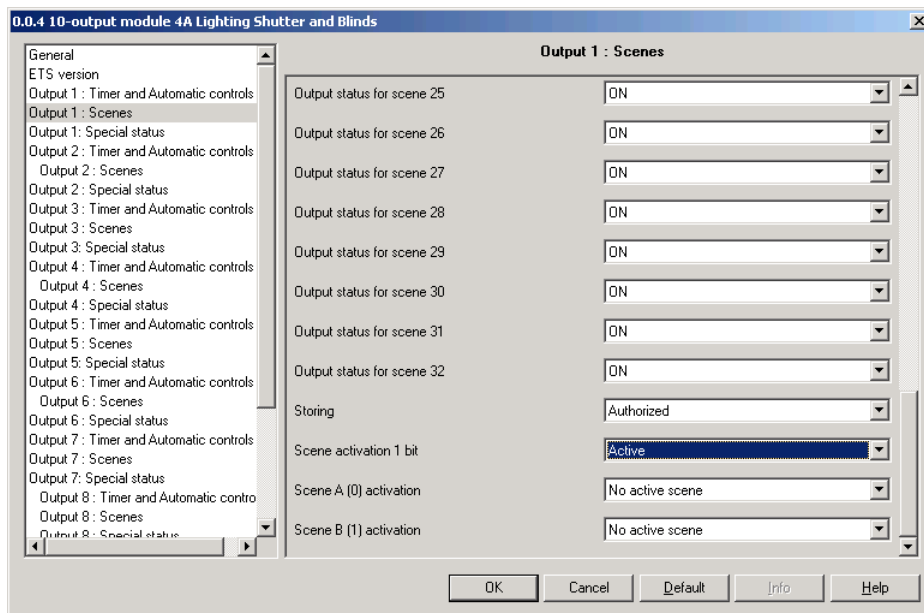

Screen 4

Designation	Description	Values
Output status for scene X	This parameter defines the status of the output associated to scene X.	ON, OFF, Not involved. Note: if the value of the parameter is Not involved, the scene will not influence this output. Default value: ON.
Storing	This parameter authorizes or forbids scene storing.	Authorized, Inhibited. Default value: Authorized.
Scene activation1 bit	This parameter allows 2 of the 32 possible scenes to be activated, with the help of the 1-bit scene object.	Inactive, Active. Default value: Inactive.
Scene A (0) activation / Scene B (1) activation*	When the parameter Scene activation 1 bit has the value Active, the parameters Scene activation A and Scene activation B must be set. These parameters define the scenes to be activated for the two values of the Scene 1 bit object.	No active scene, Scene 1 to Scene 32. Default value: No active scene.

* These parameters only are visible if the Scene activation 1 bit parameter has the value: Active.

Note: a Scenes restore object, parameterised in the general screen, allows the values linked with the outputs to be restored at the last download (see paragraph "General parameters").

B. Learning and storing in the room

This procedure modifies and stores a scene by local action on the pushbuttons located in the room.

- Activate the scene by pressing briefly on the room pushbutton that triggers the scene.
- Set the outputs to the desired status using the pushbuttons that control them individually.
- Store the output statuses by pressing the room pushbutton that triggers the scene for longer than 5 s. The storage is indicated by the status inversion of the involved outputs for 3 sec.

C. Learning and storing on the product

This procedure allows modifying and storing a scene by means of local action on the pushbuttons located on the front side of the products. This procedure also allows an output to be removed from a scene (Not involved).

- Activate the scene by pressing briefly on the room pushbutton that triggers the scene.
- Store the output statuses by pressing the room pushbutton that triggers the scene for longer than 5 s. The switching to the learning mode is indicated by the status inversion of the involved outputs for 3 sec.
- As soon as the indicators associated with the outputs blink slowly, press briefly and repeatedly the pushbuttons linked with the outputs to set the outputs to the desired status. The indicators associated with the outputs show the status chosen:
 - OFF if the value selected for the scene is OFF.
 - Red and continuously ON if the value selected for the scene is ON.
 - Red and quickly blinking if the value selected for the scene is Not involved.
- Store the status selected for this scene pressing for a time longer than 3 sec the pushbutton associated with the output. The storage is indicated by the return of the slow blinking of the indicators associated with the outputs.
- Repeat the previous step for each of the outputs of the scene.

■ **Timer and Automatic controls functions**

The Timer and automatic controls function allow the outputs to be controlled by:

- Timer functions: Timer/toggle charge over, Switching delay, Tripping delay, Switching and tripping delay, Timer.
- Automatic control functions: Authorization, Logical AND or Logical OR.

→ Parameters

The status of the output depends on the combination of the parameters Type of automatic control and Control type.

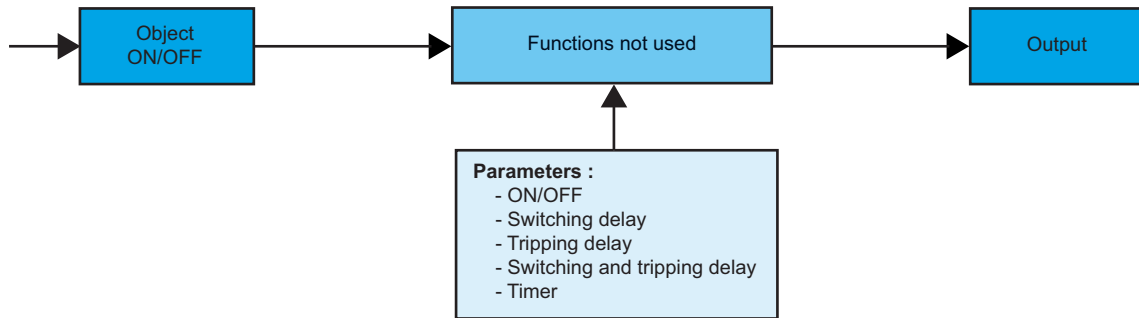

→ Parameter Setting screen: See "Screen 2"

Type of automatic control	Control type	Operation	Parameters
Not used (default value)	ON/OFF (default value)	The output is controlled directly. The Automatic control object is ignored.	
	Switching delay	The output is delayed when switching. Time delay for tripping The Automatic control object is ignored.	Switching delay: [0.5 s 24 h]* Default value: 3 min
	Tripping delay	The output is delayed when tripping. The Automatic control object is ignored.	Tripping delay: [0.5 s 24 h]* Default value: 3 min
	Switching and tripping delay	The output is delayed when switching and when tripping. The Automatic control object is ignored. The switching and tripping delay times may be different.	Switching delay: [0.5 s 24 h]* Default value: 3 min Tripping delay: [0.5 s 24 h]* Default value: 3 min
	Timer	The output is delayed for ON or for OFF. The Automatic control object is ignored.	Time switch delay: [24 h]** Default value: 3 min Timer Operation: ON, OFF Default value: ON

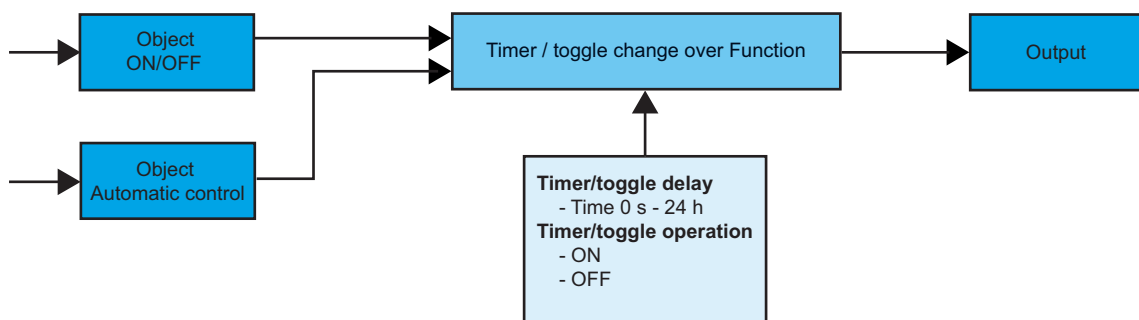

→ Parameter Setting screen: See "Screen 2"

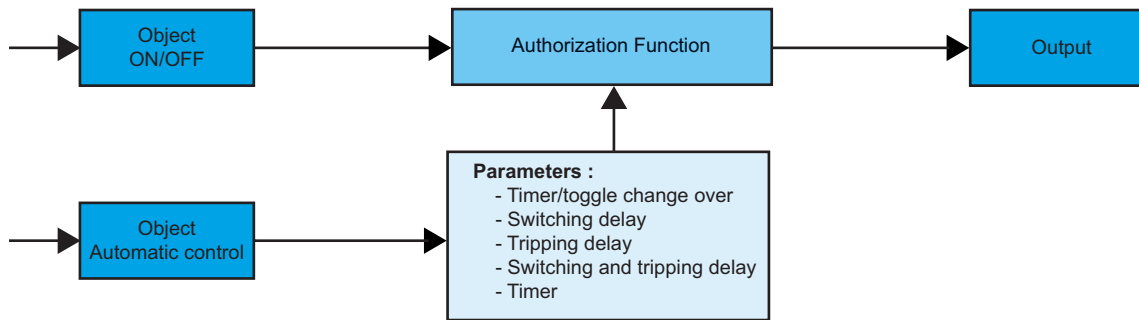

→ Parameter Setting screen: See "Screen 2"

Type of automatic control	Control type	Operation	Parameters
Authorization	Timer/toggle change over	The output is controlled directly by the ON/OFF object if the value of the Automatic control object is 1. The output is delayed for ON or for OFF if the value of the Automatic control object is 0.	Timer/toggle delay: [0 s 24 h]** Default value: 3 min <hr/> Timer/toggle operation: ON, OFF Default value: ON
	Switching delay	The output is delayed when switching if the value of the Automatic control object is 1. The commands are not taken into consideration if the value of the Automatic control object is 0.	Switching delay: [0.5 s 24 h]* Default value: 3 min
	Tripping delay	The output is delayed when tripping if the value of the Automatic control object is 1. The commands are not taken into consideration if the value of the Automatic control object is 0.	Tripping delay: [0.5 s 24 h]* Default value: 3 min
	Switching and tripping delay	The output is delayed when switching and when tripping if the value of the Automatic control object is 1. The commands are not taken into consideration if the value of the Automatic control object is 0.	Switching delay: [0.5 s 24 h]* Default value: 3 min <hr/> Tripping delay: [0.5 s 24 h]* Default value: 3 min
	Timer	The output is delayed if the value of the Automatic control object is 1. The commands are not taken into consideration if the value of the Automatic control object is 0.	Time switch delay: [0 s 24 h]** Default value: 3 min <hr/> Timer operation: ON, OFF Default value: ON

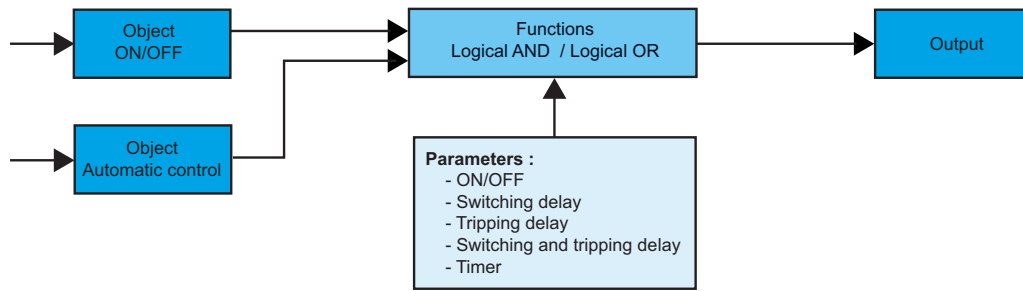

→ Parameter Setting screen: See "Screen 2".

Type of automatic control	Control type	Operation	Parameters
Logical AND	ON/OFF	The output is the result of the logical AND between the value of the ON/OFF object and the value of the Automatic control object.	
	Switching delay	The output is the result of the logical AND between the value of the ON/OFF object delayed when switching and the value of the Automatic control object.	Switching delay: [0.5 s 24 h]* Default value: 3 min
	Tripping delay	The output is the result of the logical AND between the value of the ON/OFF object delayed when tripping and the value of the Automatic control object.	Tripping delay: [0.5 s 24 h]* Default value: 3 min
	Switching and tripping delay	The output is the result of the logical AND between the value of the ON/OFF object delayed when switching and when tripping, and the value of the Automatic control object.	Switching delay: [0.5 s 24 h]* Default value: 3 min Tripping delay: [0.5 s 24 h]* Default value: 3 min
	Timer	The output is the result of the logical AND between the value of the delayed ON/OFF object and the value of the Automatic control object.	Time switch delay: [0 s 24 h]** Default value: 3 min Timer operation: ON, OFF Default value: ON

Type of automatic control	Control type	Operation	Parameters
Logical OR	ON/OFF	The output is the result of the logical OR between the value of the ON/OFF object and the value of the Automatic control object.	
	Switching delay	The output is the result of the logical OR between the value of the ON/OFF object delayed when switching and the value of the Automatic control object.	Switching delay: [0.5 s 24 h]* Default value: 3 min
	Tripping delay	The output is the result of the logical OR between the value of the ON/OFF object delayed when tripping, and the value of the Automatic control object.	Tripping delay: [0.5 s 24 h]* Default value: 3 min
	Switching and tripping delay	The output is the result of the logical OR between the value of the ON/OFF object delayed when switching and when tripping, and the value of the Automatic control object.	Switching delay: [0.5 s 24 h]* Default value: 3 min Tripping delay: [0.5 s 24 h]* Default value: 3 min
	Timer	The output is the result of the logical OR between the value of the delayed ON/OFF object and the value of the Automatic control object.	Time switch delay: [0 s 24 h]** Default value: 3 min Timer operation: ON, OFF Default value: ON

*Setting range [0.5 s 24 h]

0.5 s, 1 s, 2 s, 3 s, 5 s, 10 s, 15 s, 20 s, 30 s, 40 s, 45 s, 50 s, 1 min, 1 min 15 s, 1 min 30 s, 2 min, 2 min 30 s, 3 min, 4 min, 5 min, 6 min, 7 min, 8 min, 9 min, 10 min, 11 min, 12 min, 13 min, 14 min, 15 min, 20 min, 30 min, 40 min, 50 min, 1 h, 1 h 30 min, 2 h, 2 h 30 min, 3 h, 3 h 30 min, 4 h, 5 h, 6 h, 12 h, 24 h.

**Setting range [0 s 24 h]

0 s, 0.5 s, 1 s, 2 s, 3 s, 5 s, 10 s, 15 s, 20 s, 30 s, 40 s, 45 s, 50 s, 1 min, 1 min 15 s, 1 min 30 s, 2 min, 2 min 30 s, 3 min, 4 min, 5 min, 6 min, 7 min, 8 min, 9 min, 10 min, 11 min, 12 min, 13 min, 14 min, 15 min, 20 min, 30 min, 40 min, 50 min, 1 h, 1 h 30 min, 2 h, 2 h 30 min, 3 h, 3 h 30 min, 4 h, 5 h, 6 h, 12 h, 24 h.

■ Hours counter function (Does not concern ref. TXB202A)

The Hours counter function allows measuring the cumulated ON or OFF time of an output. The value is transmitted by the Hours counter object. A set-point triggering an alarm may be programmed. The alarm is transmitted by the Counter set-point reached object.

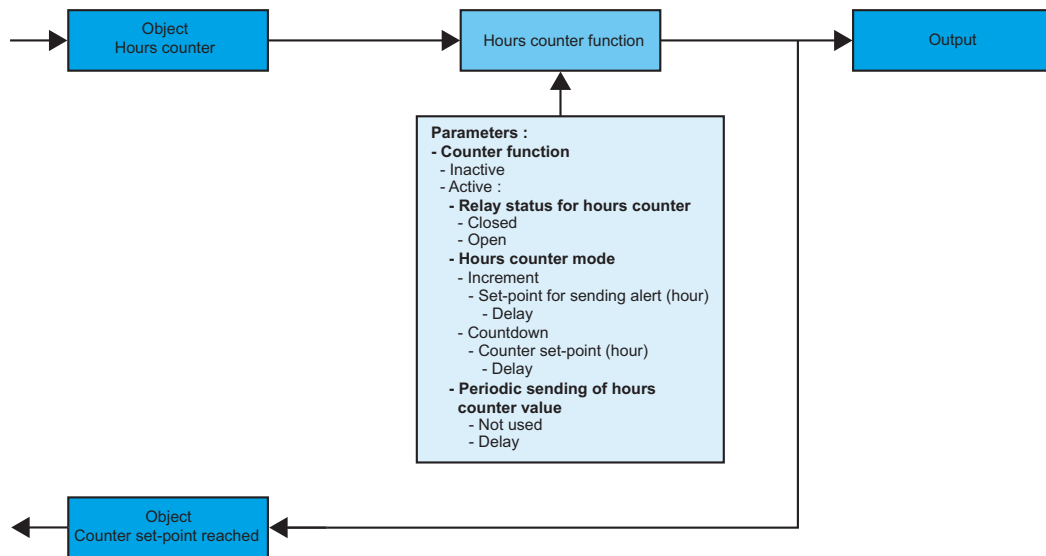

→ Parameter Setting screen: See "Screen 2".

→ Parameters

Designation	Description	Values
Counter function	This parameter allows activating the Counter function. The value of the counter can be read through the Hours counter object.	Inactive, Active. Default value: Inactive.
Relay status for hours counter*	This parameter allows choosing the status of which the cumulated time is measured.	Closed, Open. Default value: Closed.
Hours counter mode*	This parameter defines the hours counter mode.	Increment, Countdown. Default value: Increment.
Set-point for sending alert (hour)*	This parameter defines an alarm set-point for which the Counter set-point reached object will be sent.	from 0 to 10000 hours with 1-hour steps. Note: the Counter set-point reached object may be reset either by a new download or by means of a display tool. Default value: 1000.
Periodic sending of hours counter value *	This parameter defines the emission periodicity of the Hours counter object.	Not used, [5 s 24 h]** Default value: Not used
Counter set-point (hour)*	This parameter defines the duration after which an alarm is sent	from 0 to 10000 in 1-hour steps Default value: 1000

* These parameters are only visible if the Counter function parameter has the value: Active.

** Setting range [5 s 24 h]

5 s, 10 s, 30 s, 1 min, 5 min, 10 min, 20 min, 30 min, 40 min, 50 min, 1 h, 1 h 30 min, 2 h, 2 h 30 min, 3 h, 3 h 30 min, 4 h, 5 h, 6 h, 12 h, 24 h.

■ Special status

The parameters grouped in this section define the output behaviour in some special cases.

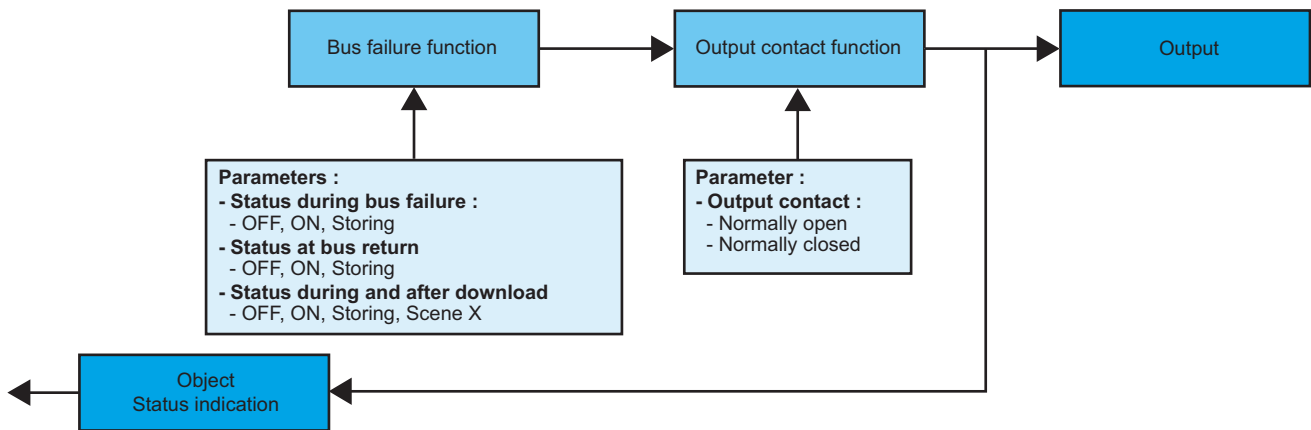

→ Parameter Setting screen: See "Screen 3".

→ Parameters

Designation	Description	Values
Status during bus failure	This parameter defines the output status to be applied during Bus failure.	OFF, ON, Storing. Default value: Storing.
Status at bus return	This parameter defines the output status applied at bus return.	OFF, ON, Storing. Default value: Storing.
Status during and after download	This parameter defines the output status to be applied during and after download.	OFF, ON, Storing, Scene X. Default value: Storing
Output contact	This parameter defines the contact type of the output.	Normally open, Normally closed. Default value: Normally open.

■ Maintenance function

The Maintenance function allows transmitting general data of the product by means of the Maintenance object.

→ Description of maintenance object (2 bytes)

0	0	0	0	0	0	0	0	0	0	0	0	0	0	0	0	1	C
---	---	---	---	---	---	---	---	---	---	---	---	---	---	---	---	---	---

C: Operating mode of the product	0: Auto 1: Manual
----------------------------------	----------------------

3. Main characteristics

Produit	TXA204A/B/C/D	TXA208A/B/C/D	TXA206A/B/C/D	TXA207C	TXA202A
Max. number of group addresses	254	254	254	254	254
Max. number of links	255	255	255	255	255
Objects total	51	98	75	122	26
per lighting output	12	12	12	12	6
for scenes restoration	1	1	1	1	1
for maintenance	1	1	1	1	1

4. Physical addressing

Modular devices:

To perform physical addressing or to check for bus presence, press the lighted pushbutton located above the label holder on the right of the product.

Indicator on = bus presence and product in physical addressing.

The product remains in physical addressing until the physical address has been transmitted by ETS. Press again to exit physical addressing mode.

Physical addressing may be performed in Auto or Manual (↔) mode.

Flush mounted devices TXB202A:

Press pushbutton S1/Addr briefly (for less than 2 s) to perform physical addressing or to check for bus presence.

Indicator Addr ON = bus presence and product in physical addressing.

The product remains in physical addressing until the physical address has been transmitted by ETS. Press again to exit physical addressing mode.

